



Art.-Nr: FMDS423WL-AZ
Emergency light Self-contained
Surface mounting, 3 h, IP65, Zinc die-cast, Anthracite

Robust zinc die-cast safety luminaire for mounting on the ceiling and for illuminating escape and emergency routes.

Wireless central control and monitoring for large installations of up to 50,000 luminaires with Wireless Professional.



More information

www.rp-group.com/en/item/FMDS423WL-AZ



TECHNICAL DATA

Luminaire type	Emergency light
Mounting	Surface mounting
Pictograph	No
Illuminant	LED
Housing material	Zinc die-cast
Housing color	Anthracite
Protection type (IP)	IP65
Impact resistance (IK)	8
Certification	WEEE, CE, D-Sign, HACCP, Ball protected, 5 years warranty
Insulation class	1
Supply	Self-contained
Monitoring	Wireless Professional (WL)
Bridging time	3 h
Battery	LiFePO4 3,2 V/3,3 Ah
Operating mode	Non-maintained / maintained
Input voltage AC	230 V
Input frequency	50 Hz
Power max.	7,5 W
Power maintained	5,7 W
Power non-maintained	0,8 W
Ambient temperature maintained mode	-5 °C to 40 °C



Ambient temperature non-maintained mode	-5 °C to 40 °C
Depth	58 mm
Width	262 mm
Height	188 mm
Weight	2.07
Weight incl. packaging	2.17
Connection cross-section	2.5 mm ²
Switching input	Yes
Emergency light blocking	Yes
Battery connection	Connector
Dimming function	Yes
Luminous flux mains	250 lm
Luminous flux emergency	520 lm
Customs tariff number	94056180
GTIN	4260766557286

TECHNICAL DRAWING

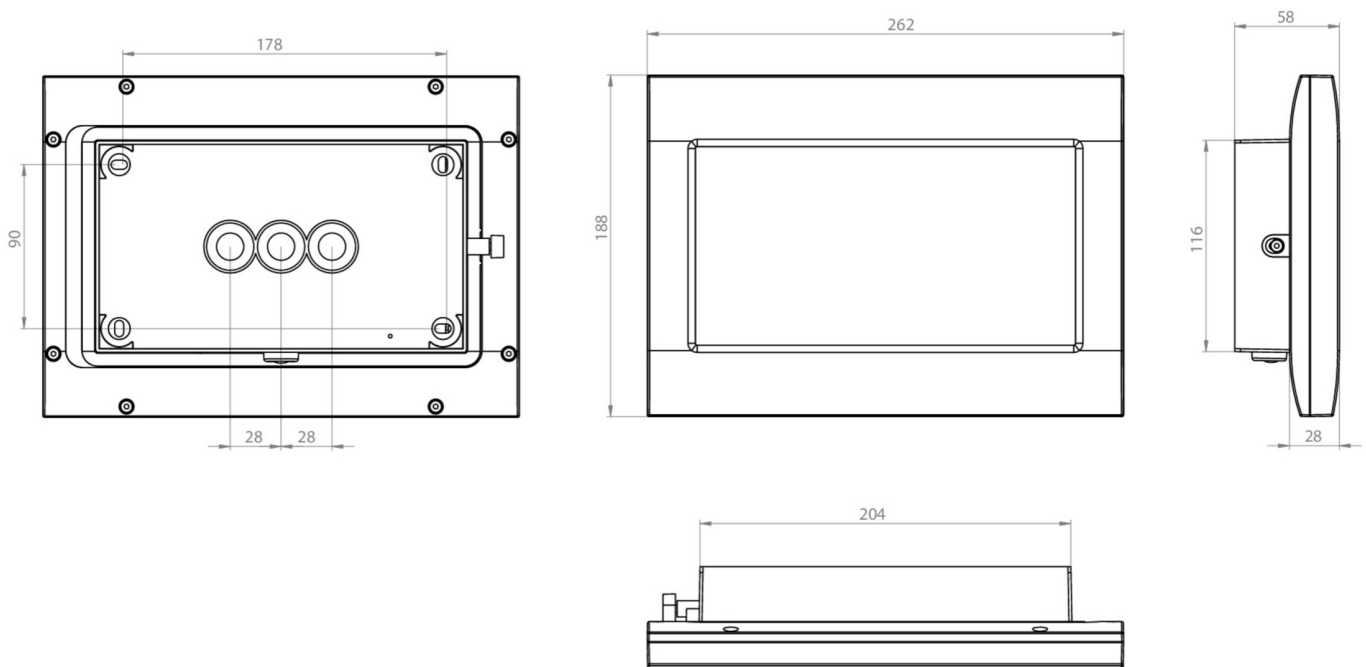



ACCESSORY LIST

FMDA001 - Ceiling bracket, one-sided, white - Professional bracket for FM emergency lights

FMDA002 - Professional ceiling bracket (double-sided) for FM emergency lights, white

FMDA001-AZ - High-quality ceiling bracket for FM luminaires, one-sided, anthracite

FMDA002-AZ - Double-sided ceiling bracket for emergency lighting - anthracite, FM-compatible

FMWA001 -

FMFH -

As of: 10.07.2026 - Subject to technical changes and errors.