



Art.-Nr: FMW408SC-TT
Exit sign Self-contained
Wall mounting, 8 h, 20 m, IP65, Zinc die-cast, White, Set of
pictograms, low-temperature batteries

Robust zinc die-cast emergency exit sign luminaire for mounting on the wall and for identifying emergency and escape routes.

The pictogram is fitted on the inside where it is protected by a transparent pane. Automatic monitoring of safety luminaire with SelfControl. Planning certainty is provided by tool-free, variable use of the pictograms on site. A set of pictograms corresponding to DIN ISO 7010 (arrow to the right, left, up and down) is supplied as standard. The designation "TT" stands for **low-temperature batteries**. These special **lithium iron phosphate batteries** are designed to function reliably even at low temperatures. They offer stable performance and a long lifespan, even under demanding conditions.



More information

www.rp-group.com/en/item/FMW408SC-TT



TECHNICAL DATA

Luminaire type	Exit sign
Mounting	Wall mounting
Recognition distance	20 m
Pictograph	Set
Illuminant	LED
Housing material	Zinc die-cast
Housing color	White
Protection type (IP)	IP65
Impact resistance (IK)	8
Certification	WEEE, CE, 5 years warranty, D-Sign
Insulation class	1
Supply	Self-contained
Monitoring	SelfControl (SC)
Bridging time	8 h
Battery	LiFePO4 3,2 V/3,3 Ah
Operating mode	Non-maintained / maintained
Input voltage AC	180 V - 250 V



Input frequency	50 Hz
Power max.	5,2 W
Power maintained	3,4 W
Power non-maintained	2 W
Ambient temperature maintained mode	-15 °C to 40 °C
Ambient temperature non-maintained mode	-15 °C to 40 °C
Depth	58 mm
Width	262 mm
Height	188 mm
Weight	2.05
Weight incl. packaging	2.15
Connection cross-section	2,5 mm ²
Switching input	Yes
Emergency light blocking	No
Battery connection	Connector
Dimming function	No
Customs tariff number	94056180
GTIN	4262483022573



TECHNICAL DRAWING

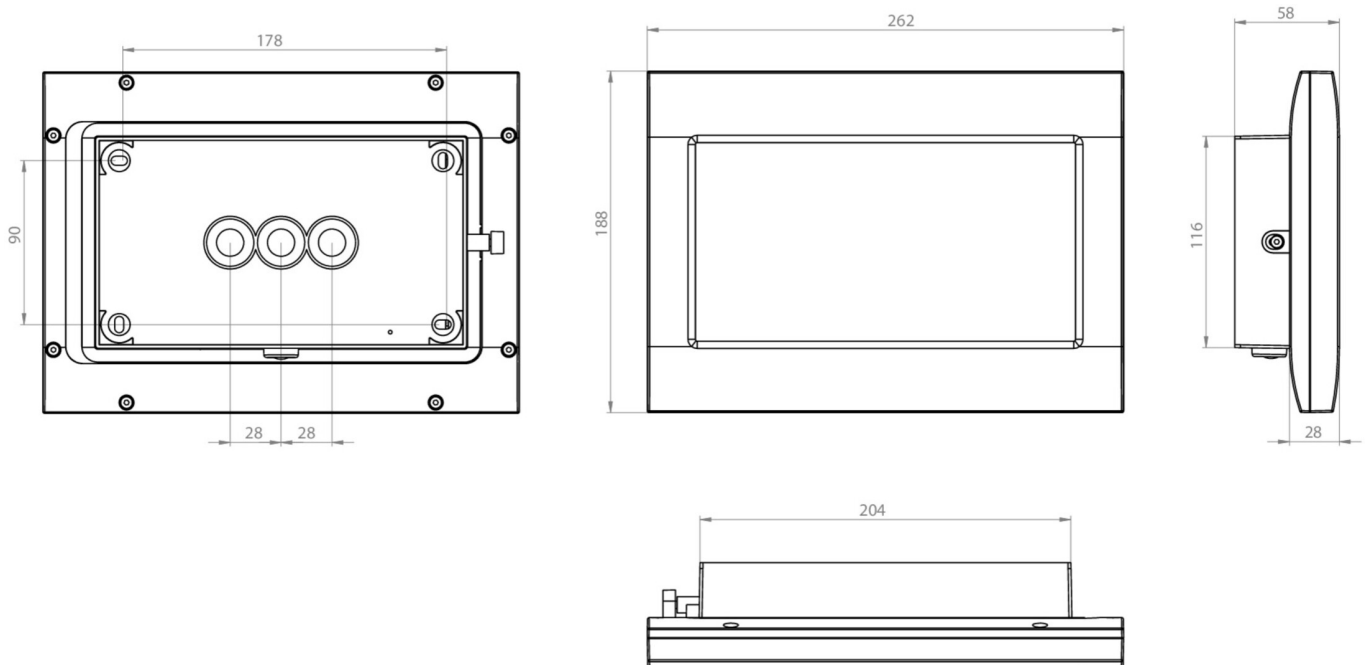

ACCESSORY LIST

FMWA001 -

FMDA001 - Ceiling bracket, one-sided, white - Professional bracket for FM emergency lights

FMDA002-AZ - Double-sided ceiling bracket for emergency lighting - anthracite, FM-compatible

FMFH -

FMDA001-AZ - High-quality ceiling bracket for FM luminaires, one-sided, anthracite

FMDA002 - Professional ceiling bracket (double-sided) for FM emergency lights, white

LFPN3233.01-TT - Battery

As of: 10.07.2026 - Subject to technical changes and errors.