



Art.-Nr: GABD408SC
Exit sign Self-contained
Surface mounting, 1 h, 40 m, IP40, Polycarbonate, White,
Piktogram as required

Emergency exit sign luminaire with plastic pane for surface mounting on the ceiling and for identifying emergency and escape routes. It is based on the design of the A series luminaire family, which provides solutions for any mounting and has won the German Design Award for its uniform, straight-line design. The luminaires are equipped with modern LED illuminants and provide flexibility through their interchangeable pictograms.

Automatic monitoring of safety luminaire with SelfControl. Two requested pictograms (arrow to the right, left, up, down or white) are supplied as standard.



More information
www.rp-group.com/en/item/GABD408SC



TECHNICAL DATA

Luminaire type	Exit sign
Mounting	Surface mounting
Recognition distance	40 m
Pictograph	acc. to Specification
Illuminant	LED
Housing material	Polycarbonate
Housing color	White
Protection type (IP)	IP40
Impact resistance (IK)	5
Certification	WEEE, CE, 5 years warranty
Insulation class	2
Supply	Self-contained
Monitoring	SelfControl (SC)
Bridging time	1 h
Battery	LiFePO4 3,2 V/1,2 Ah
Operating mode	Non-maintained / maintained
Input voltage AC	180 V - 250 V
Input frequency	50 Hz



Power max.	4,2 W
Power maintained	3,3 W
Power non-maintained	0,9 W
Ambient temperature maintained mode	-5 °C to 40 °C
Ambient temperature non-maintained mode	-5 °C to 40 °C
Depth	80.9 mm
Width	417.5 mm
Height	245.5 mm
Weight	1.31
Weight incl. packaging	1.96
Switching input	Yes
Emergency light blocking	No
Battery connection	Connector
Dimming function	No
Customs tariff number	94056120
GTIN	4262483022597



TECHNICAL DRAWING

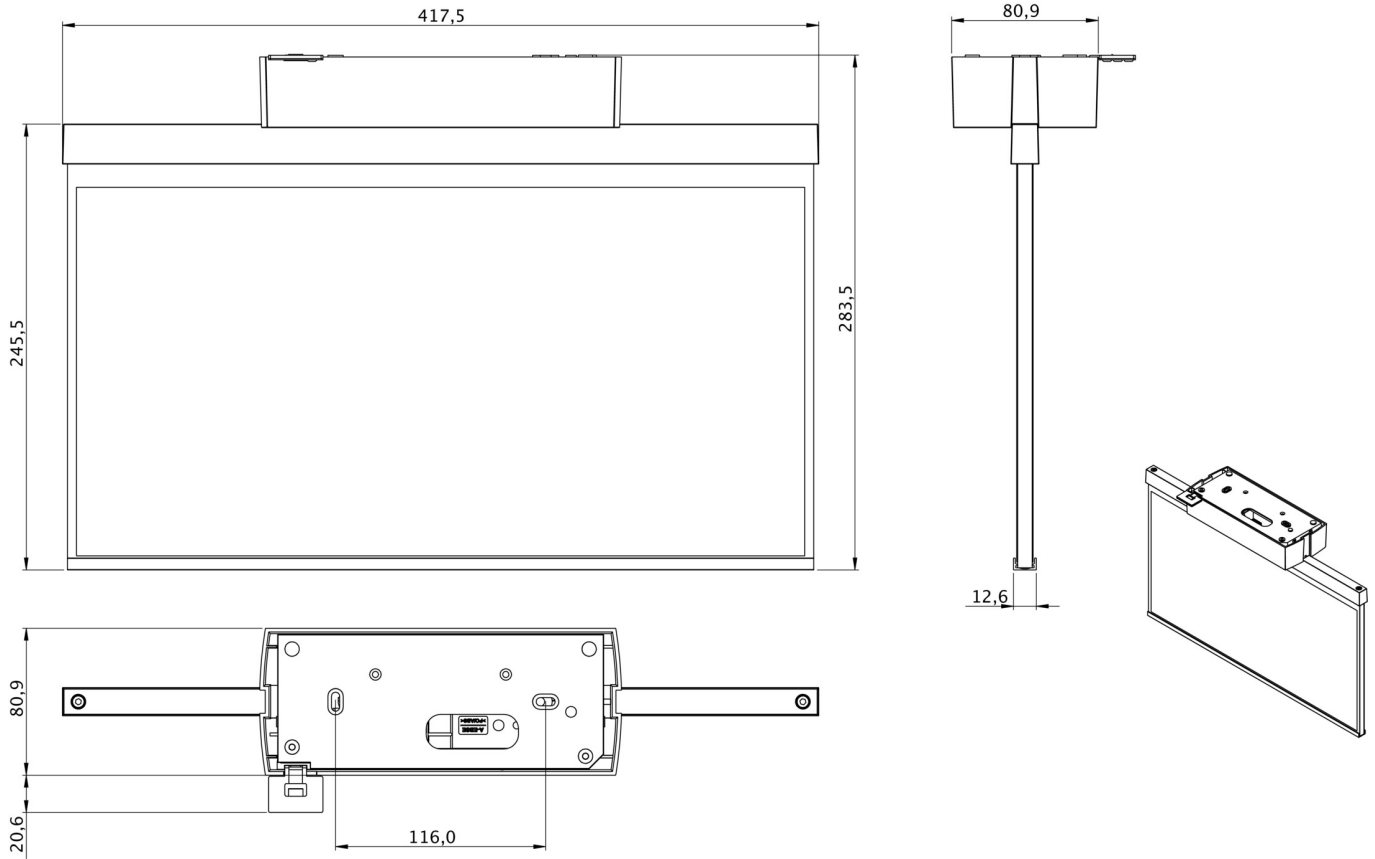

As of: 07.07.2026 - Subject to technical changes and errors.