



Art.-Nr: AMD008SC-E
Exit sign Self-contained
Surface mounting, SelfControl (SC), 8 h, 22 m, IP40, Zinc die-cast, Stainless steel

Modern zinc die-cast emergency exit sign luminaire for surface mounting on the ceiling. Escape and emergency routes can be identified on either one or two sides.

It is part of the A series luminaire family, which provides solutions for any mounting and has won the German Design Award for its uniform, straight-line design.

Automatic monitoring of safety luminaire with SelfControl. Planning certainty is provided by tool-free, variable use of the pictograms on site. A set of pictograms corresponding to DIN ISO 7010 (arrow to the right, left, up and down) is supplied as standard.



More information

www.rp-group.com/en/item/AMD008SC-E



TECHNICAL DATA

Luminaire type	Exit sign
Mounting	Surface mounting
Recognition distance	22 m
Pictograph	Set
Illuminant	LED
Housing material	Zinc die-cast
Housing color	Stainless steel
Protection type (IP)	IP40
Impact resistance (IK)	≥ 3
Certification	WEEE, CE
Insulation class	2
Supply	Self-contained
Monitoring	SelfControl (SC)
Bridging time	8 h
Battery	NIMH 4,8 V/2,0 Ah
Operating mode	Non-maintained / maintained
Input voltageAC	230 V



Input frequency	50 / 60 Hz
Power max.	4,6 W
Power maintained	3,4 W
Power non-maintained	0,35 W
Ambient temperature maintained mode	-5 °C to 40 °C
Ambient temperature non-maintained mode	-5 °C to 40 °C
Depth	80 mm
Width	236 mm
Height	184 mm
Weight	1.23
Weight incl. packaging	1.59
Connection cross-section	2.5 mm ²
Switching input	Yes
Emergency light blocking	Yes
Battery connection	Connector
Dimming function	Yes
Customs tariff number	94056180
EAN	4260581714086



TECHNICAL DRAWING

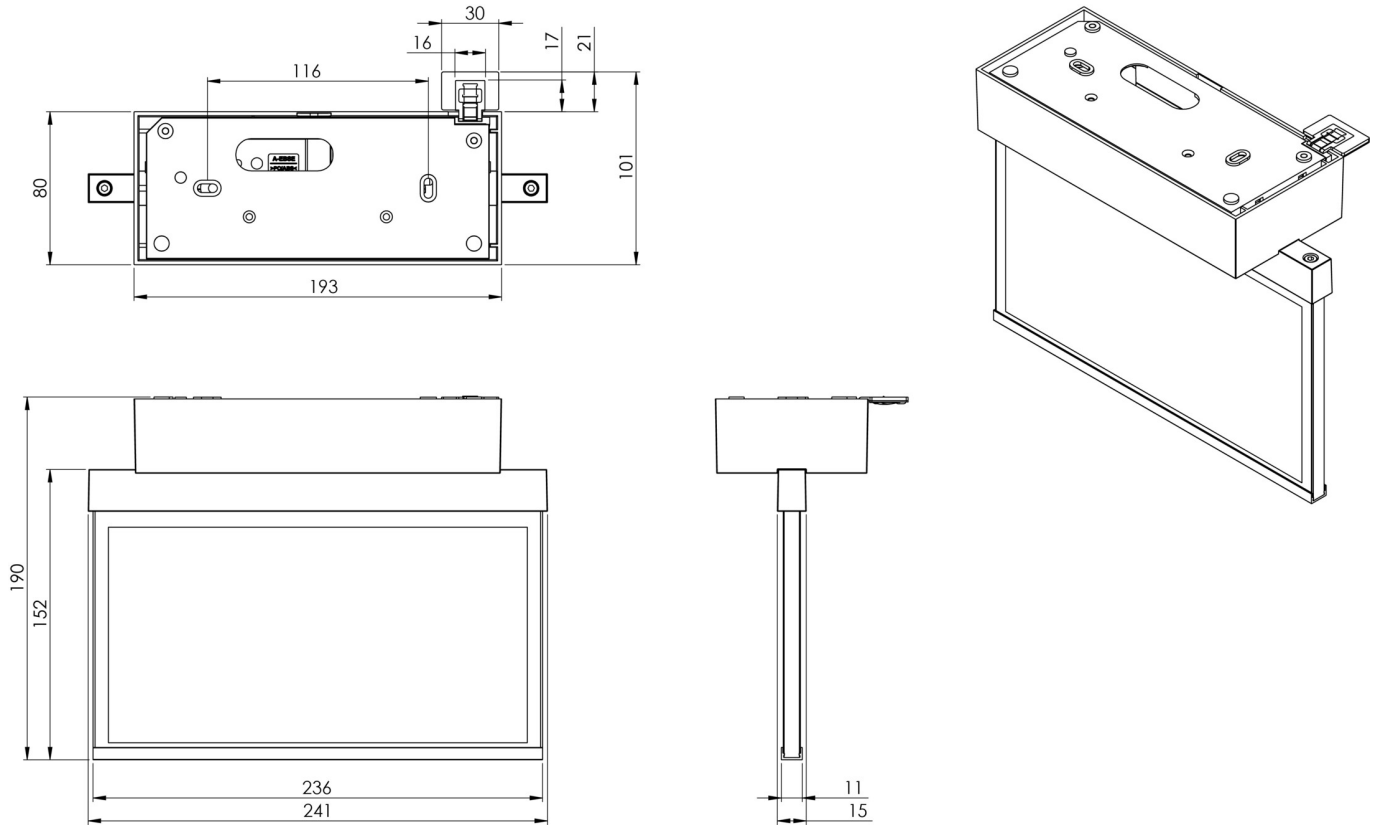

ACCESSORY LIST

AM-X-APA - Surface-mounted adapter AM/AX

RELATED PRODUCTS

Art.-No.	Image	Monitoring	Supply	Color	Investment	Automatic log	Maintenance level	Remote maintenance	max. luminaires	Single luminaire monitoring
AMD008SC		SelfControl (SC)	Single battery	RAL 9003	€	no	high	no	unlimited	itself
AMD008SC-AZ		SelfControl (SC)	Single battery	RAL 7016	€	no	high	no	unlimited	itself

As of: 14.05.2025 - Subject to technical changes and errors.