



Art.-Nr: AXCC008SC-AZ
Exit sign Self-contained
Rope ceiling installation, SelfControl (SC), 8 h, 30 m, IP20,
Zinc die-cast, Anthracite

Modern zinc die-cast emergency exit sign luminaire with wire suspension for recessed mounting in the ceiling. Escape and emergency routes can be identified on either one or two sides.

It is part of the A series luminaire family, which provides solutions for any mounting and has won the German Design Award for its uniform, straight-line design.

Automatic monitoring of safety luminaire with SelfControl. Planning certainty is provided by tool-free, variable use of the pictograms on site. A set of pictograms corresponding to DIN ISO 7010 (arrow to the right, left, up and down) is supplied as standard.



More information

www.rp-group.com/en/item/AXCC008SC-AZ



TECHNICAL DATA

Luminaire type	Exit sign
Mounting	Rope ceiling installation
Recognition distance	30 m
Pictograph	Set
Illuminant	LED
Housing material	Zinc die-cast
Housing color	Anthracite
Protection type (IP)	IP20
Impact resistance (IK)	≥ 3
Certification	WEEE, CE
Insulation class	2
Supply	Self-contained
Monitoring	SelfControl (SC)
Bridging time	8 h
Battery	NIMH 4,8 V/2,0 Ah
Operating mode	Non-maintained / maintained
Input voltageAC	230 V



Input frequency	50 / 60 Hz
Power max.	5,6 W
Power maintained	3,2 W
Power non-maintained	0,35 W
Ambient temperature maintained mode	-5 °C to 40 °C
Ambient temperature non-maintained mode	-5 °C to 40 °C
Depth	80 mm
Width	312 mm
Height	181 mm
Installation length	176 mm
Installation width	68 mm
Installation height	40 mm
Weight	2.02
Weight incl. packaging	2.51
Connection cross-section	2.5 mm ²
Switching input	Yes
Emergency light blocking	Yes
Battery connection	Connector
Dimming function	Yes
Customs tariff number	94056180
EAN	4260581715076



TECHNICAL DRAWING

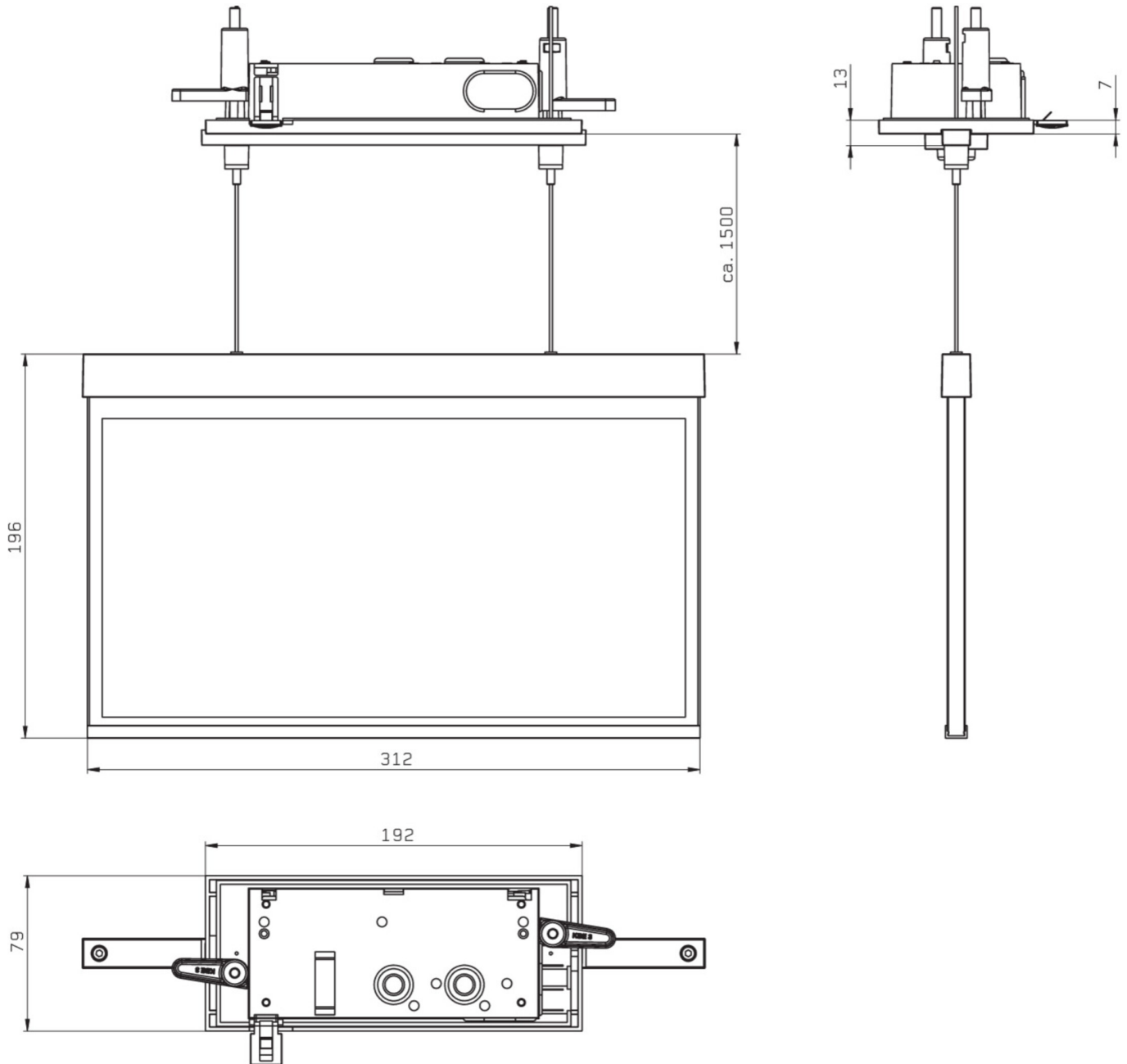

ACCESSORY LIST

AM-XBE -



RELATED PRODUCTS

Art.-No.	Image	Monitoring	Supply	Color	Investment	Automatic log	Maintenance level	Remote maintenance	max. luminaires	Single luminaire monitoring
AXCC008SC		SelfControl (SC)	Single battery	RAL 9003	€	no	high	no	unlimited	itself
AXCC008SC-E		SelfControl (SC)	Single battery	Edelstahl	€	no	high	no	unlimited	itself

As of: 14.05.2025 - Subject to technical changes and errors.