



Art.-Nr: EARR021SC-AZ
Emergency light Self-contained
, SelfControl (SC), 1 h, , IP40, Zinc die-cast, Anthracite

High-grade zinc-aluminium safety luminaire for fitting on the ceiling. The round safety luminaire, which adapts to the ceiling design.

Thanks to the snap-in mechanism between the upper and lower part, the luminaire has a harmonious look and appears closed all the way round. The luminaire is connected to the mains in the ceiling section. When closed, the luminaire is powered via contact plugs. This greatly simplifies mounting and makes convenient connection possible despite the small size of the luminaire.

Automatic monitoring of safety luminaire with SelfControl. The innovative integrated lens holder with a rapid fitting fixture permits the flexible use of various lens types. Using the right lens allows the distribution of light to be matched perfectly to the application and simplifies illumination which satisfies all relevant standards. A round lens and hall lens are supplied with every luminaire, allowing it to be adapted perfectly to the respective mounting situation. Other lenses, such as a spotlight lens, beam lens or H lens, are available as options.



More information

www.rp-group.com/en/item/EARR021SC-AZ



TECHNICAL DATA

Luminaire type	Emergency light
Pictograph	No
Illuminant	LED
Housing material	Zinc die-cast
Housing color	Anthracite
Protection type (IP)	IP40
Impact resistance (IK)	≥ 3
Certification	WEEE, CE
Insulation class	2
Supply	Self-contained
Monitoring	SelfControl (SC)
Bridging time	1 h
Battery	NIMH 4,8 V/2,0 Ah
Operating mode	Non-maintained / maintained



Input voltageAC	230 V
Input frequency	50 / 60 Hz
Power max.	3,7 W
Power maintained	1,8 W
Power non-maintained	0,18 W
Height	39 mm
Diameter	104 mm
Weight	0.41
Weight incl. packaging	0.45
Connection cross-section	2.5 mm ²
Switching input	Yes
Emergency light blocking	No
Battery connection	Connector
Dimming function	Yes
Luminous flux mains	110 lm
Luminous flux emergency	240 lm
Customs tariff number	94056180
EAN	4260581717384

TECHNICAL DRAWING

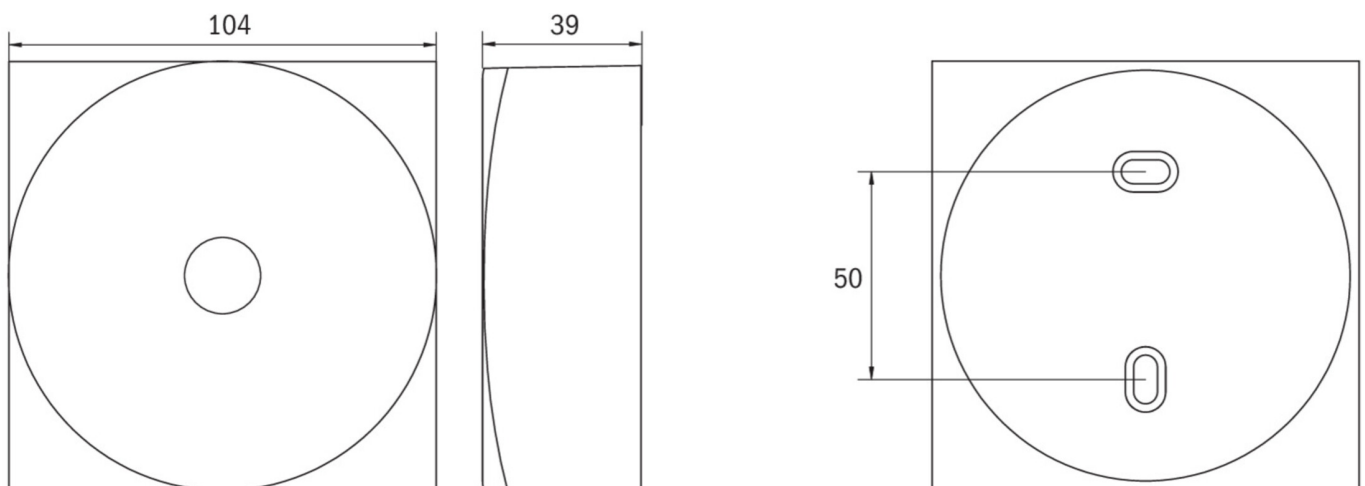



ACCESSORY LIST

ILD-APA-02 - IL surface-mounted adapter

As of: 17.05.2025 - Subject to technical changes and errors.