



Art.-Nr: EERL023SC-AZ
Emergency light Self-contained
Ceiling mounting, SelfControl (SC), 3 h, , IP20, Zinc die-cast,
Anthracite

High-grade zinc-aluminium safety luminaire for fitting in the ceiling.

The compact design permits mounting in a 68mm opening in the ceiling. Alongside the usual recessed ceiling mounting, it can also be mounted in conventional and fire protection sockets. It is secured with ease using tension springs or a screw connection on the box.

Automatic monitoring of safety luminaire with SelfControl. The innovative integrated lens holder with a rapid fitting fixture permits the flexible use of various lens types. Using the right lens allows the distribution of light to be matched perfectly to the application and simplifies illumination which satisfies all relevant standards. A round lens and hall lens are supplied with every luminaire, allowing it to be adapted perfectly to the respective mounting situation. Other lenses, such as a spotlight lens, beam lens or H lens, are available as options.



More information

www.rp-group.com/en/item/EERL023SC-AZ



TECHNICAL DATA

Luminaire type	Emergency light
Mounting	Ceiling mounting
Pictograph	No
Illuminant	LED
Housing material	Zinc die-cast
Housing color	Anthracite
Protection type (IP)	IP20
Impact resistance (IK)	≥ 3
Certification	WEEE, CE
Insulation class	2
Supply	Self-contained
Monitoring	SelfControl (SC)
Bridging time	3 h
Battery	NIMH 4,8 V/2,0 Ah
Operating mode	Non-maintained / maintained



Input voltage AC	230 V
Input frequency	50 / 60 Hz
Power max.	3 W
Power maintained	1,6 W
Power non-maintained	0,35 W
Ambient temperature maintained mode	-5 °C to 40 °C
Ambient temperature non-maintained mode	-5 °C to 40 °C
Height	4 mm
Diameter	88 mm
Installation dimensions Diameter	68 mm
Weight	0.41
Weight incl. packaging	0.54
Connection cross-section	2.5 mm ²
Switching input	Yes
Emergency light blocking	Yes
Battery connection	Connector
Dimming function	Yes
Luminous flux mains	140 lm
Luminous flux emergency	140 lm
Customs tariff number	94056180
GTIN	4260682151179



TECHNICAL DRAWING

Maße EER / EEQ



Einzelbatterie-Elektronik-Box (UH-1)

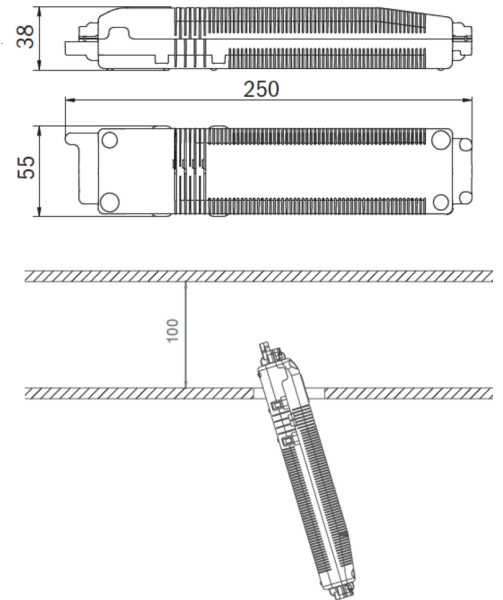

Lochsausschnitt EER / EEQ

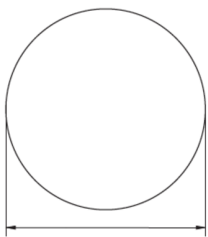

EEx023: 74mm
EEx029: 68mm





EEx029: Schalterdose notwendig (nicht im Lieferumfang enthalten)

ACCESSORY LIST

NIMHHT4820Q - Battery

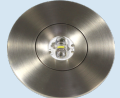

RELATED PRODUCTS

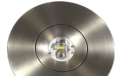
Art.-No.	Image	Monitoring	Supply	Color	Investment	Automatic log	Maintenance level	Remote maintenance	max. luminaires	Single luminaire monitoring
EERL023SC		SelfControl (SC)	Single battery	RAL 9003	€	no	high	no	unlimited	itself
EERL023SC-E		SelfControl (SC)	Single battery	Edelstahl	€	no	high	no	unlimited	itself
EERL023WL		Wireless Professional (WL)	Single battery	RAL 9003	€€	yes	low	yes	1,000 per system	central
EERL023WL-AZ		Wireless Professional (WL)	Single battery	RAL 7016	€€	yes	low	yes	1,000 per system	central
EERL023WL-E		Wireless Professional (WL)	Single battery	Edelstahl	€€	yes	low	yes	1,000 per system	central

As of: 19.09.2025 - Subject to technical changes and errors.