

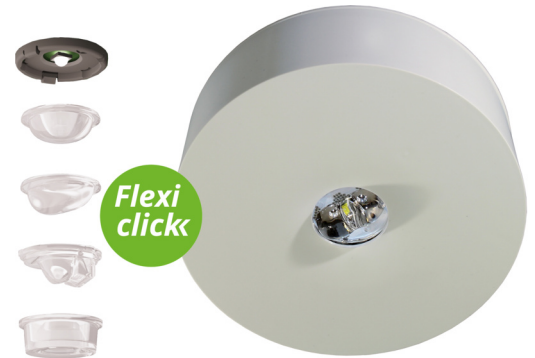

## Emergency luminaire Art.-No.: ILDL428WL

The IL LED safety light with its unobtrusive design is a real all-rounder. It is ready for almost all requirements and always offers the right solution. The status LED within the lens does not disturb the homogenous look of the luminaire. The innovative integrated lens carrier with quick-mounting device enables the flexible use of different lens types depending on the application. Round and corridor lenses are already included in the scope of delivery for each light and enable perfect adaptation to the respective installation situation. All versions of the IL are available for surface and recessed mounting.

The IL surface-mounted light consists of only 2 parts, with the ceiling attachment containing the mains connection terminals. The actual lamp is installed without tools and is not connected to the mains voltage when it is dismantled.



### TECHNICAL DATA

Luminaire type	Emergency luminaire
Mounting	Ceiling mounted
Pictograph	No
Illuminant	LED
Housing material	Polycarbonate
Colour	RAL 9003
Mechanical rating IP	40
Impact resistance IK	≥ 3
Protection class	2
Supply	Single battery
Monitoring	WL - Wireless Professional
Operation time	8 h
Battery	3.2V / 3.3 Ah LiFePO4
Operation mode	maintained/non-maintained mode
Input Voltage AC	230 V
Input Frequency Hz	50 / 60 Hz
Power consumption max.	3,4 W
Power consumption maintained	2,3 W
Power consumption non-maintained	0,4 W



Ambient temperature maintained mode	-5 °C / 40 °C
Ambient temperature non-maintained mode	-5 °C / 40 °C
Height	36 mm
Diameter	100 mm
Weight	0.19 kg
Weight incl. Packaging	0.23 kg
Connection cross-section	2.5 mm
Switching input L'	Yes
Emergency light blocking	No
Battery connector	Plug
Dimming function	Yes
Luminous flux mains mode	130 lm
Luminous flux emergency mode	125 lm
Customs tariff number	94056120
Country of origin	Germany
EAN	4260682155719

## TECHNICAL DRAWING

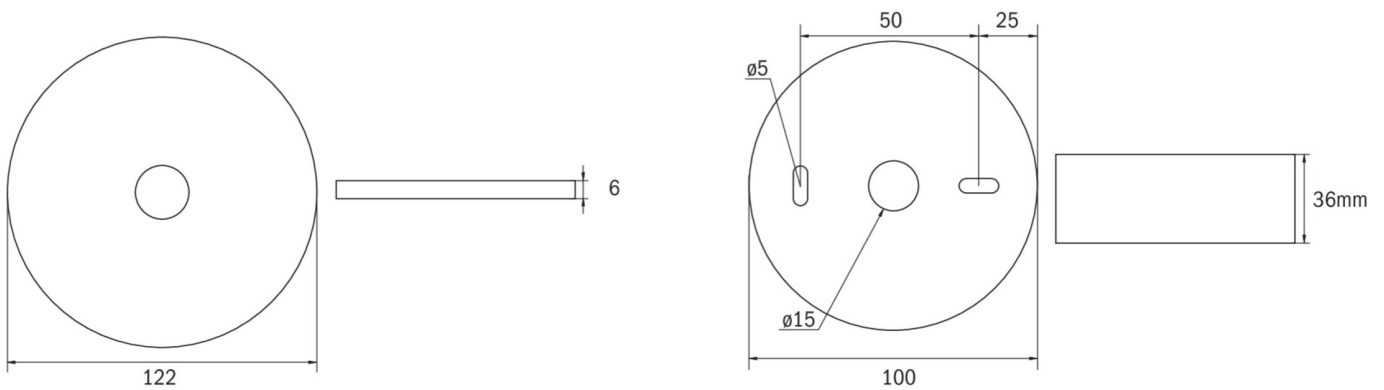



## ACCESSORIES

- ILD-APA-02 - IL surface mount adapter-02
- IL-IK10-AZ - Surface mounting housing for ILD, white
- IL-IK10-W - Surface mounting housing for ILD, white
- ILDE - recessed frame for all versions of ILD, plastic
- ILB1 - IL cover, square
- ILB2 - IL cover, square with fringe
- BALLPLX-ILD - Ball protection 200x200x62mm incl. fastening
- IL-IP65-K - Surface mounting housing IP65 for ILD, white
- LSYS-B4 - 4x Beam lens for lights with a lens system, for
- LSYS-F4 - 4x corridor lenses for luminaires with lens
- LSYS-R4 - 4x round lenses for luminaires with lens
- LSYS-S4 - 4x Spotlens for luminaires with lens system.