



Emergency luminaire Art.-No.: ILEL428WL

The discreet designed LED emergency luminaire IL is a true all-rounder. Whether as self-contained emergency light or to connect to central battery systems: it is fit for most challenges and always provides the right solution. The innovative integrated lens carrier with quick-mounting device enables the flexible use of different lens types depending on the application. Round and corridor lenses are already included in the scope of delivery for each light and enable perfect adaptation to the respective installation situation.

The IL recessed mounted luminaire consists of 2 parts, the recessed mounted part includes the power supply terminals. The electronic part of the luminaire is at disassembly mains voltage free.



TECHNICAL DATA

Luminaire type	Emergency luminaire
Mounting	Recessed ceiling
Pictograph	No
Illuminant	LED
Housing material	Polycarbonate
Colour	RAL 9003
Mechanical rating IP	20
Impact resistance IK	≥ 3
Protection class	2
Supply	Single battery
Monitoring	WL - Wireless Professional
Operation time	8 h
Battery	3.2V / 3.3 Ah LiFePO4
Operation mode	maintained/non-maintained mode
Input Voltage AC	230 V
Input Frequency Hz	50 / 60 Hz
Power consumption max.	3,4 W
Power consumption maintained	2,3 W
Power consumption non-maintained	0,4 W
Ambient temperature maintained mode	-5 °C / 40 °C
Ambient temperature non-maintained mode	-5 °C / 40 °C



Height	84 mm
Diameter	122 mm
Install. dim. height	80 mm
Install. dim. diameter	105 mm
Weight	0.23 kg
Weight incl. Packaging	0.29 kg
Connection cross-section	2.5 mm
Switching input L'	Yes
Emergency light blocking	No
Battery connector	Plug
Dimming function	Yes
Luminous flux mains mode	130 lm
Luminous flux emergency mode	125 lm
Customs tariff number	94056120
Country of origin	Germany
EAN	4260682155856



TECHNICAL DRAWING

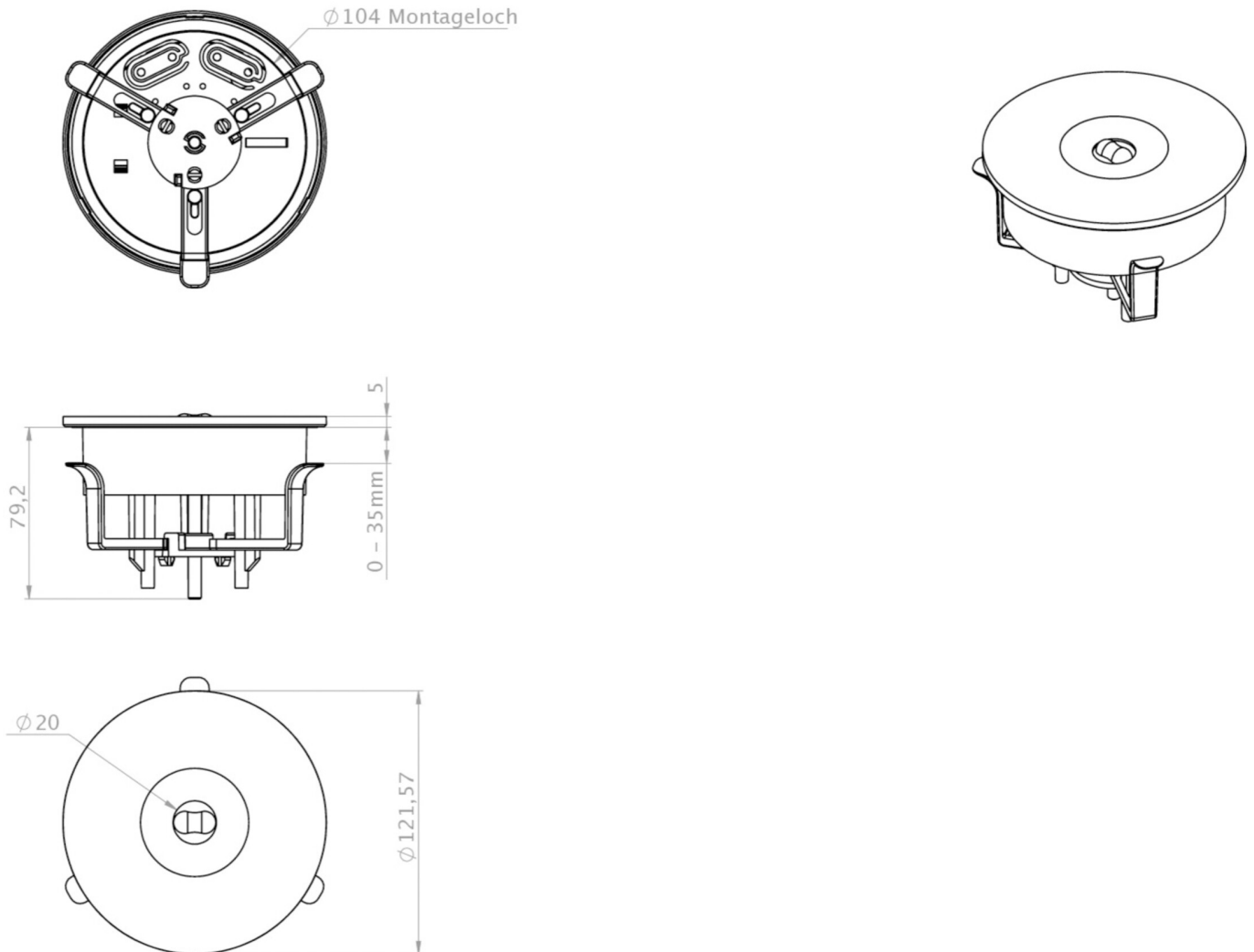

ACCESSORIES

- BALLPLX-ILE - Ball protection 190x190x62mm incl. fastening
- LSYS-B4 - 4x Beam lens for lights with a lens system, for
- LSYS-F4 - 4x corridor lenses for luminaires with lens
- LSYS-R4 - 4x round lenses for luminaires with lens
- LSYS-S4 - 4x Spotlens for luminaires with lens system.