



Exit sign

Art.-No.: KDU411SC

Slim design high-grade plastic luminaire for universal mounting (wall/ ceiling or eventual at wall bracket through supplied adapter). This luminaire provides additional downward lighting to enhance safety at the egress route.

Applicable for maintained or non-maintained operation mode. Improved reliability through being easy to install and the universal use of pictograms. Signs according to EN 60598-1, EN 60598-2-22 and EN 1838 norms.



TECHNICAL DATA

Luminaire type	Exit sign
Mounting	Universal
Viewing distance	22 m
Pictograph	Set
Illuminant	LED
Housing material	Polycarbonate
Colour	RAL 9003
Mechanical rating IP	43
Impact resistance IK	3
Protection class	2
Supply	Single battery
Monitoring	Self-Control
Operation time	1 h
Battery	6.4V/3.3Ah LiFeP04
Operation mode	maintained/non-maintained mode
Input Voltage AC	230 V
Input Frequency Hz	50 Hz
Power consumption max.	4,3 W
Power consumption maintained	3,5 W
Power consumption non-maintained	0,9 W
Ambient temperature maintained mode	-5 °C / 40 °C
Ambient temperature non-maintained mode	-5 °C / 40 °C
Length	70 mm
Width	260 mm



Height	155 mm
Weight	0.8 kg
Weight incl. Packaging	1 kg
Connection cross-section	1.5 mm
Switching input L'	Yes
Emergency light blocking	No
Battery connector	Plug
Dimming function	No
Customs tariff number	94056120
Country of origin	Germany
EAN	4260766553417

TECHNICAL DRAWING

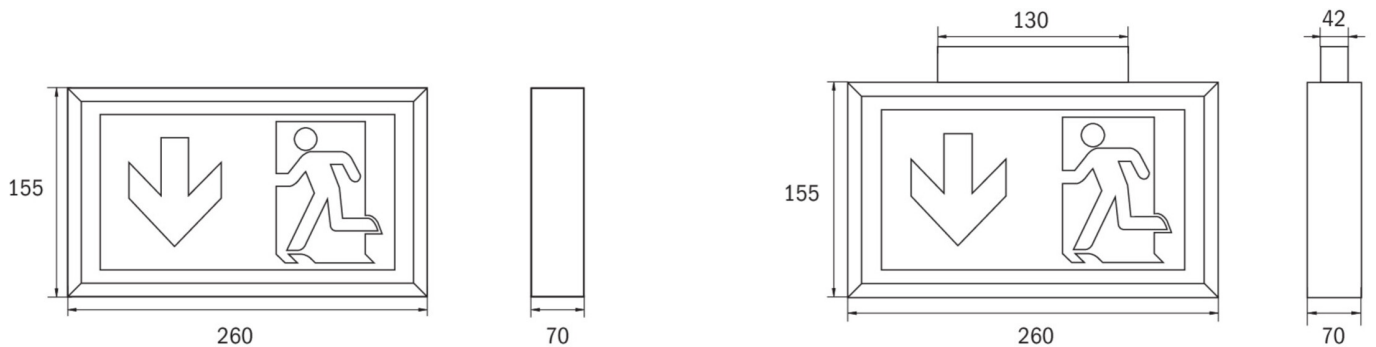

ACCESSORIES

- DSA - cord suspension set 1,5m
- BALL1 - Ball protection (6W) 320x220x120mm
- 2PW-EB -
- 2DW-EB -
- BALLPLX-KD - Ball protection 380x280x100mm incl. fastening