



Exit sign Art.-No.: KLU1110

Slim design high-grade plastic luminaire for universal mounting (wall/ ceiling or as wall bracket with the included adapter). This luminaire provides additional downwards lighting to enhance safety at the egress route. Applicable for maintained or non-maintained operation mode. The easy to install and universally useable pictograms provide planning security. Signs according to EN 60598-1, EN 60598-2-22 and EN 1838 norms.



TECHNICAL DATA

Luminaire type	Exit sign
Mounting	Universal
Viewing distance	34 m
Pictograph	Set
Illuminant	LED
Housing material	Polycarbonate
Colour	RAL 9003
Mechanical rating IP	43
Impact resistance IK	≥ 3
Protection class	2
Supply	Central power supply system
Monitoring	None
Operation time	CPS
Operation mode	Maintained mode
Input Voltage AC	110 V
Input Frequency Hz	50 / 60 Hz
Input Voltage DC	110 V
Power consumption max.	4,7 W
Power consumption maintained	4,7 W
Power consumption non-maintained	0 W
Ambient temperature maintained mode	-25 °C / 40 °C
Ambient temperature non-maintained mode	-25 °C / 40 °C
Length	78 mm
Width	390 mm



Height	220 mm
Weight	1.24 kg
Weight incl. Packaging	1.4 kg
Connection cross-section	1.5 mm
Switching input L'	No
Emergency light blocking	No
Battery connector	None
Dimming function	No
Luminous flux mains mode	340 lm
Luminous flux emergency mode	340 lm
Customs tariff number	94056120
Country of origin	Germany
EAN	4260581719906

TECHNICAL DRAWING

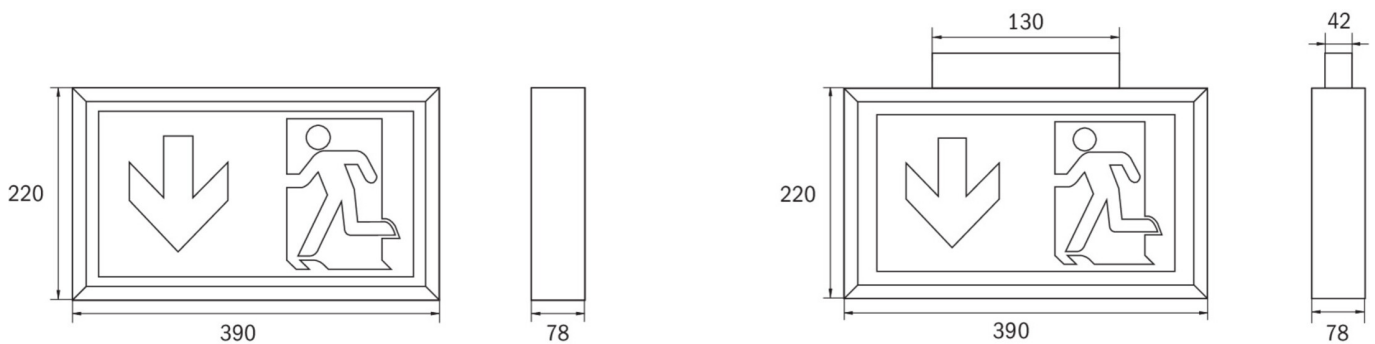

ACCESSORIES

- DSA - cord suspension set 1,5m
- BALL2 - Ball protection (8W) 450x280x125mm
- 2PW-EB -
- 2DW-EB -