



Exit sign Art.-No.: KXU413SC

Innovative polycarbonate edge luminaire for universal mounting wall/ceiling/recessed ceiling. Tapered design housing for appealing area perception. Applicable for maintained or nonmaintained operation mode. Improved reliability through easy to install universal use of pictograms. Universal insertion pictogram set (left, right, down, up) included. Signs according to EN 60598-1, EN 60598-2-22 and EN 1838 norms.

- Also available as combined safety light/rescue sign with ERT-LED and clear cover
- Simple pictogram mounting (one and double-sided), plugging-technique



TECHNICAL DATA

Luminaire type	Exit sign
Mounting	Universal
Viewing distance	30 m
Pictograph	Set
Illuminant	LED
Housing material	Polycarbonate
Colour	RAL 9003
Mechanical rating IP	40
Impact resistance IK	≥ 3
Protection class	2
Supply	Single battery
Operation time	3 h
Battery	6.4V/3.3Ah LiFeP04
Operation mode	maintained/non-maintained mode
Input Voltage AC	230 V
Input Frequency Hz	50 Hz
Power consumption max.	4,1 W
Power consumption maintained	3,3 W
Power consumption non-maintained	0,4 W
Ambient temperature maintained mode	-5 °C / 35 °C
Ambient temperature non-maintained mode	-5 °C / 40 °C
Length	48 mm



Width	332 mm
Height	242 mm
Weight	0.95 kg
Weight incl. Packaging	1.06 kg
Connection cross-section	1.5 mm
Switching input L'	Yes
Emergency light blocking	No
Battery connector	Plug
Dimming function	No
Luminous flux mains mode	225 lm
Luminous flux emergency mode	225 lm
Customs tariff number	94056120
Country of origin	Germany
EAN	4260766557422

TECHNICAL DRAWING

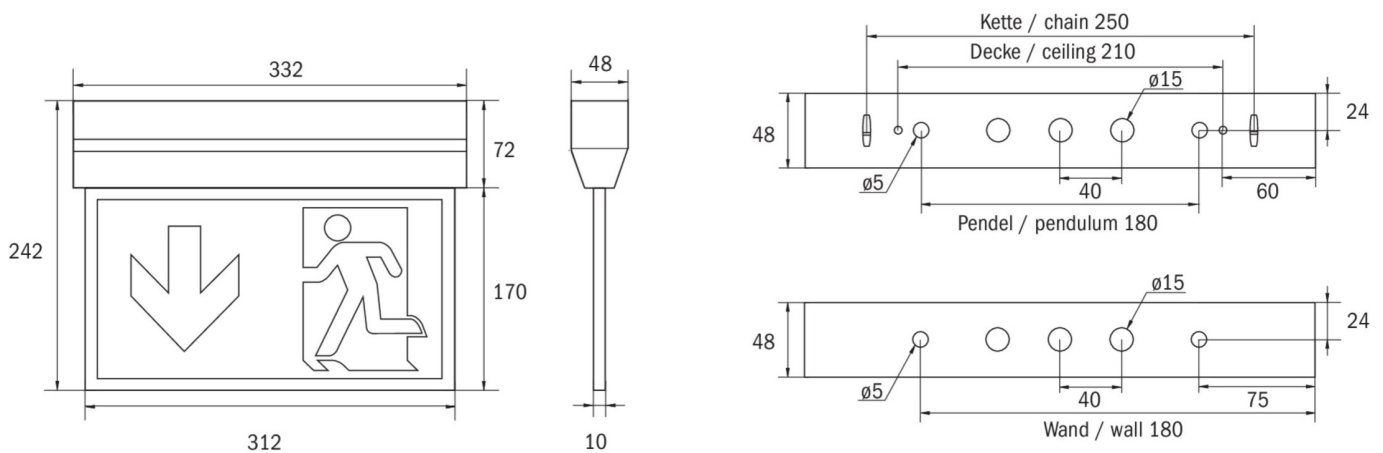

ACCESSORIES

- KXE-EB - KX - recessed frame SB incl. test button
- AWX001 - Wall bracket, white
- DSA - cord suspension set 1,5m
- 2PW-EB -
- 2DW-EB -
- KXBE - KX concrete box 01+02

State: 19.04.2024 - Subject to technical changes