



Exit sign Art.-No.: MMD403SC

The advantages of the LED combined with a compact shape come together to a modern design. The high quality slim body is made from zinc-aluminium die-cast. The variable use and toolless change of pictograms provide planning security on site.

LED escape route luminaire in accordance with DIN EN 60598-1, EN 60598-2-22, EN ISO 7010 and DIN EN 1838.

Optional with DUO-LED for additional light output downwards.



TECHNICAL DATA

Luminaire type	Exit sign
Mounting	Ceiling mounted
Viewing distance	21 m
Pictograph	Set
Illuminant	LED
Housing material	Zinc die-cast
Colour	RAL 7016
Mechanical rating IP	40
Impact resistance IK	≥ 3
Protection class	1
Supply	Single battery
Monitoring	Self-Control
Operation time	3 h
Battery	6.4V/1.2Ah LiFeP04
Operation mode	maintained/non-maintained mode
Input Voltage AC	230 V
Input Frequency Hz	50 Hz
Power consumption max.	4,3 W
Power consumption maintained	3,4 W
Power consumption non-maintained	0,9 W
Ambient temperature maintained mode	-5 °C / 40 °C
Ambient temperature non-maintained mode	-5 °C / 40 °C
Length	52 mm
Width	236 mm



Height	138 mm
Weight	0.22 kg
Weight incl. Packaging	0.22 kg
Connection cross-section	1.5 mm
Switching input L'	Yes
Emergency light blocking	No
Battery connector	Plug
Dimming function	No
Customs tariff number	94056180
Country of origin	Germany
EAN	4260766556555

TECHNICAL DRAWING

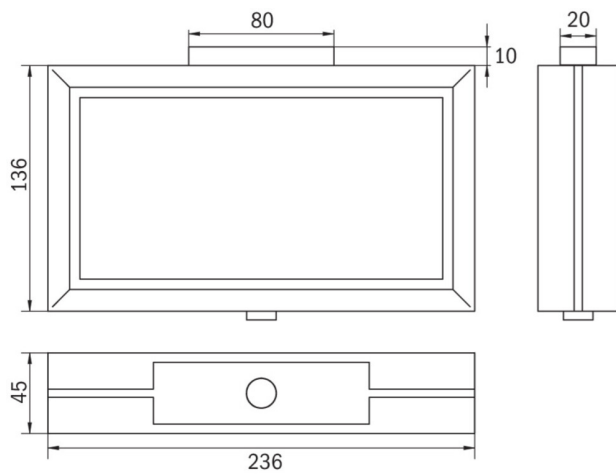

MMD

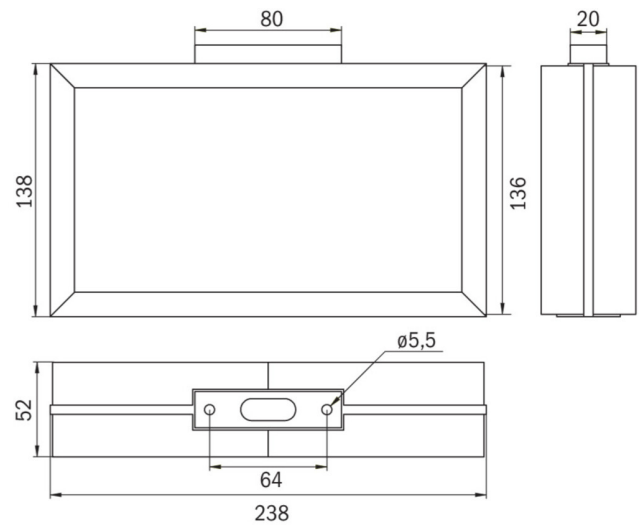

MMD_IP65