



Exit sign Art.-No.: PFW018-COOL

Plastic luminaire for the marking and lighting of escape and rescue routes according to DIN EN 60598-1, DIN EN 60598-2-22 and EN 1838. For single or double sided labeling. Available for central power systems or as self-contained emergency luminaire.

The COOL light is equipped with an external battery housing for installation in the building. The installation of the lamp can be done outdoors or in cold stores.



TECHNICAL DATA

Luminaire type	Exit sign
Mounting	Wall mounted
Viewing distance	24 m
Pictograph	Set
Illuminant	LED
Housing material	Polycarbonate
Colour	RAL 9003
Mechanical rating IP	65
Impact resistance IK	5
Protection class	1
Supply	Single battery
Monitoring	None
Operation time	3 h
Battery	4,8V/2,0Ah NiMH
Operation mode	maintained/non-maintained mode
Input Voltage AC	230 V
Input Frequency Hz	50 / 60 Hz
Power consumption max.	6,1 W
Power consumption maintained	4,5 W
Power consumption non-maintained	0,35 W
Ambient temperature maintained mode	-25 °C / 40 °C
Ambient temperature non-maintained mode	-25 °C / 40 °C
Length	370 mm
Width	105 mm



Height	152 mm
Weight	1.07 kg
Weight incl. Packaging	1.2 kg
Connection cross-section	2.5 mm
Switching input L'	Yes
Emergency light blocking	Yes
Battery connector	Plug
Dimming function	Yes
Luminous flux mains mode	220 lm
Luminous flux emergency mode	150 lm
Customs tariff number	94056020
Country of origin	Germany
EAN	4260581710750



TECHNICAL DRAWING

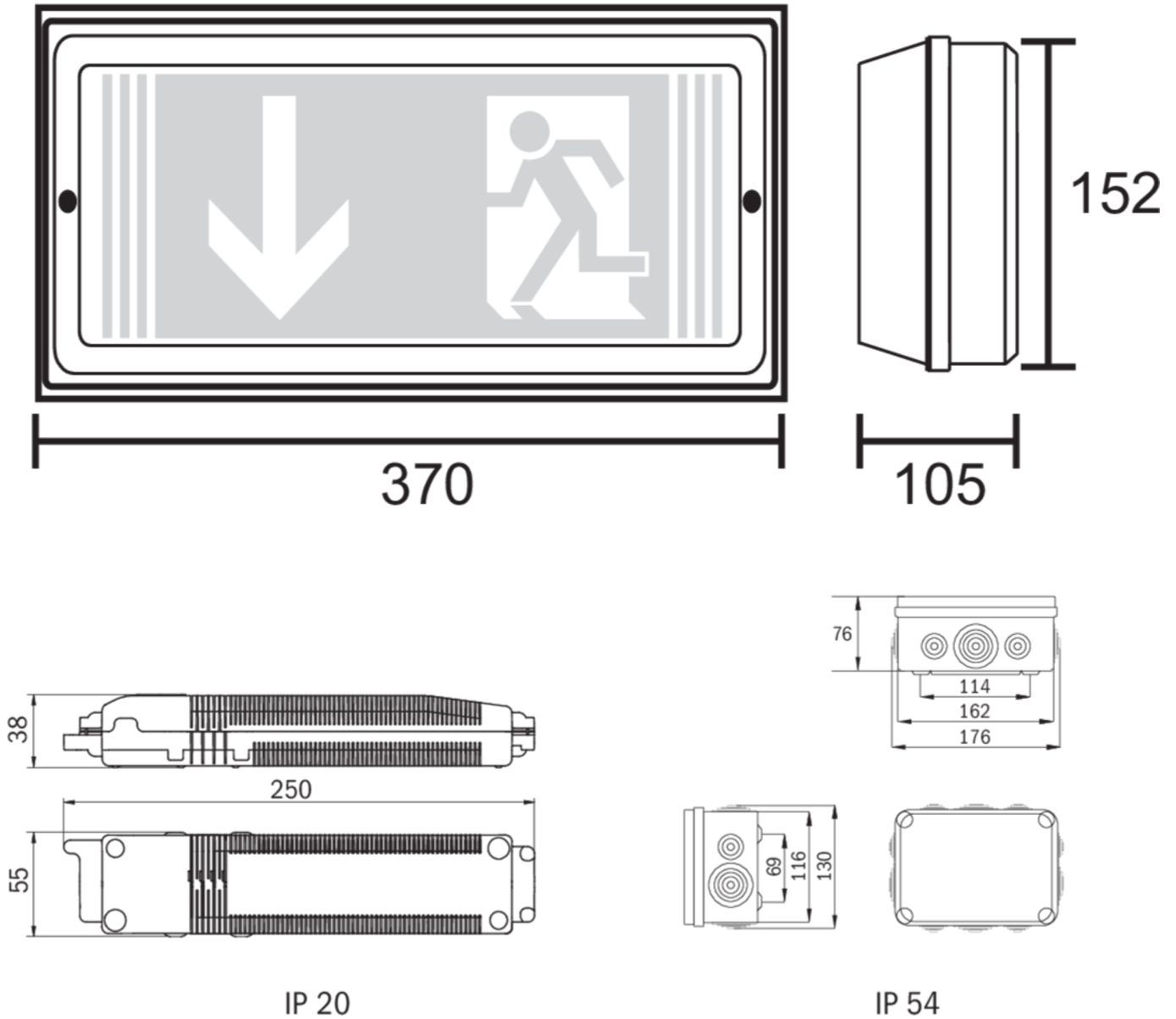

ACCESSORIES

BALL2 - Ball protection (8W) 450x280x125mm