



**Art.-Nr: TR-22381B-WW**  
**LED track spotlight "TRACK22", 184x150x85mm, beam angle 44°, 22W, 2500lm, 3000K, CRI >80, IP20, anthracite, Triac dimmbar**

LED track luminaires, Track series, with multi-adapter for 3-phase busbars, 230V. Housing made from die-cast aluminium, white or anthracite, powder-coated. Can be rotated 350° horizontally and swivelled 90° vertically. Interchangeable PC lenses, non-yellowing, for various beam angles (20° - 60°). Operating unit can be switched or dimmed (DALI dimmer), installed.



More information

[www.rp-group.com/en/item/TR-22381B-WW](http://www.rp-group.com/en/item/TR-22381B-WW)



## TECHNICAL DATA

Dimensions	
Product dimensions Length	184 mm
Product dimensions Width	150 mm
Product dimensions Height	85 mm
Product weight	0.65 kg
Packaging dimensions	
Packaging dimensions Length	208 mm
Packaging dimensions Width	140 mm
Packaging dimensions Height	110 mm
Weight incl. packaging	0.67 kg
Color	
Color	Black
Housing material	
Housing material	Aluminium
Certification	
Certification	CE, RoHS
Protection type (IP)	IP20
Glow wire test	650 °C
Electrical connection	
Type of dimming	TRIAC



System performance	22 W
Input voltage AC	220-240V / 50-60Hz V
Starting current	1.5 A
Power factor	0.9 PF
<b>power supply</b>	
Number of power supply units on LS B10A	45 pcs.
Number of power supply units on LS B16A	72 pcs.
Number of power supply units at LS C10A	60 pcs.
Number of power supply units at LS C16A	96 pcs.
Electrical design	with internal control gear, Dimmable
<b>Light data</b>	
Light source	LED
Rated luminous flux	2500 lm
Colour rendering index	> 80 Ra
Colour tolerance	4
Beam angle	44 °
Color temperature	3000 K
Light color	830
UGR	24.8
Service life	50000 h, L70
Light yield	114 lm/w
<b>Temperatures</b>	
Ambient temperature (Min)	-20 °C
Ambient temperature (Max)	40 °C



TEXT.LICHTVERTEILUNG

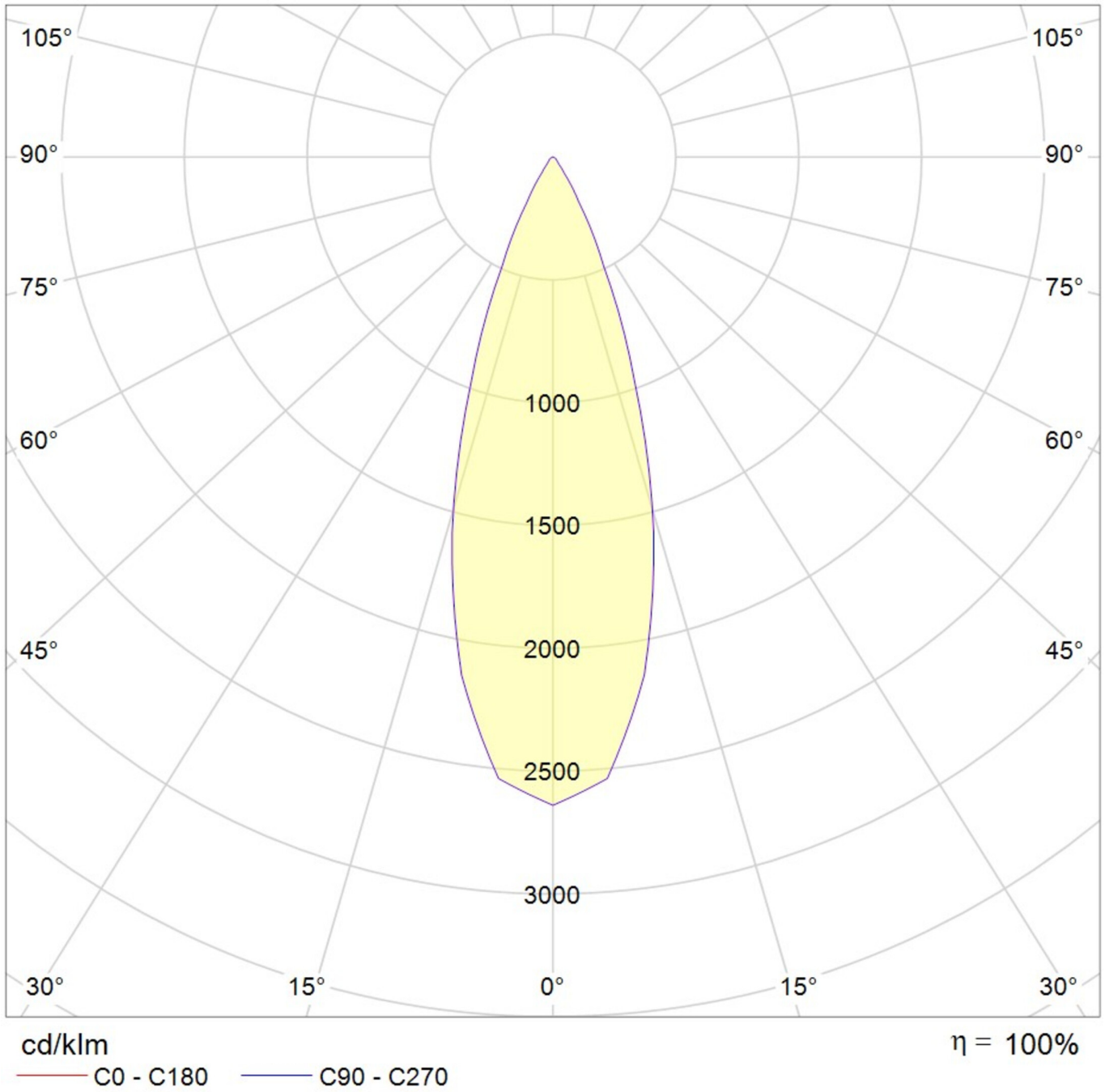

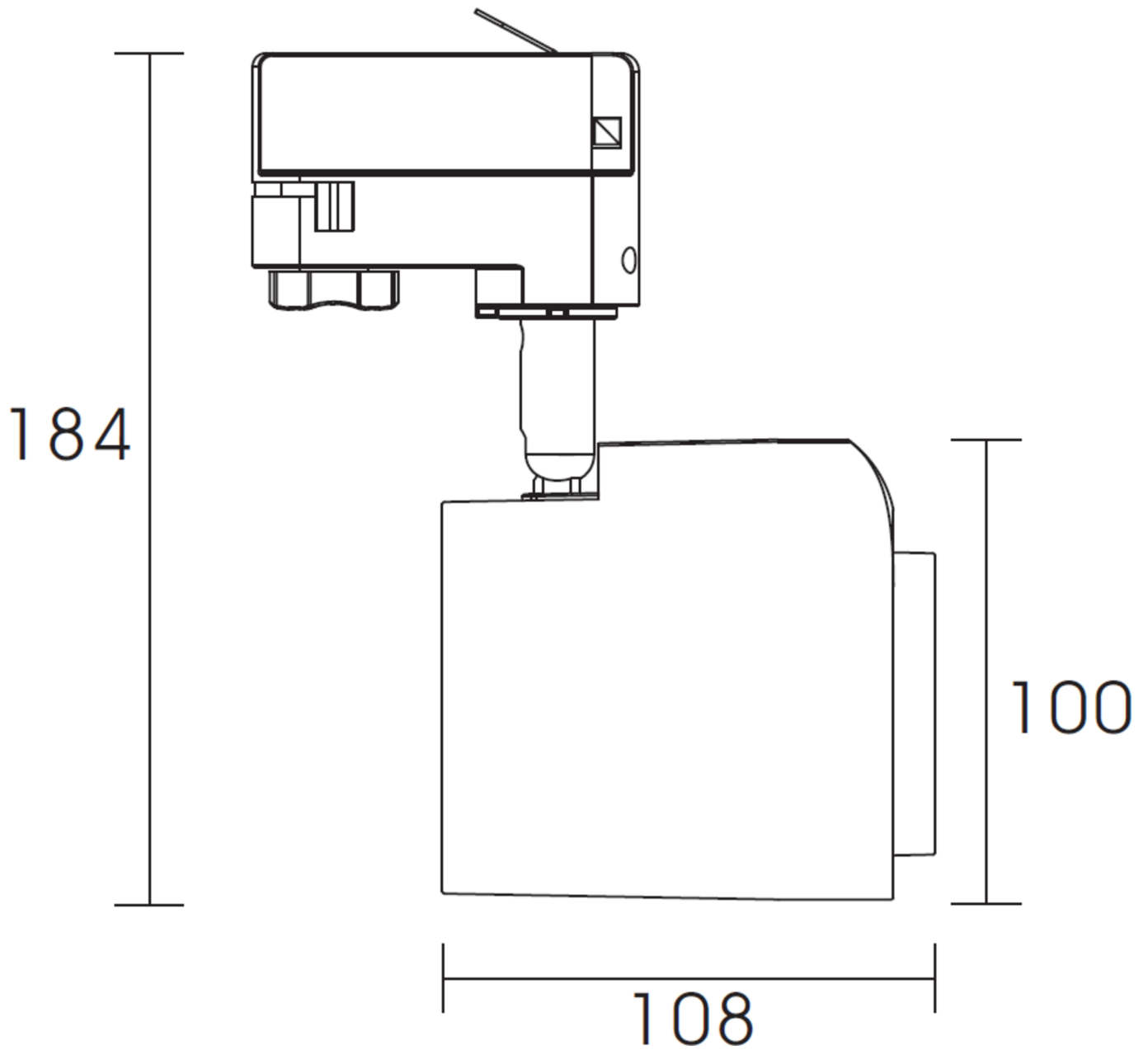

As of: 10.04.2025 - Subject to technical changes and errors.