



Art.-Nr: UEMR418WL
Exit sign Self-contained
Recessed wall mounting, Wireless Professional (WL), 8 h, 20 m, IP40, , Transparent

LED emergency exit sign luminaire for recessed wall mounting, without a frame and flush to the wall. Frameless, flush-mounted LED emergency exit sign for wall installation. It integrates seamlessly into the wall without visible frames, screws, or protruding elements, ensuring an unobtrusive appearance.

An integrated leveling system allows for precise and easy alignment of the light with the wall surface.

The pictogram set is inserted internally and attached without solvents.

Suitable accessories are available for installation in concrete or masonry:

UEMR-BWE – Concrete mounting housing

UEMR-TWE – Drywall mounting frame

Wireless central control and monitoring for large installations of up to 50,000 luminaires with Wireless Professional. Planning certainty is provided by tool-free, variable use of the pictograms on site. A set of pictograms corresponding to DIN ISO 7010 (2x man in the door and 2 straight arrows) are supplied as standard.



More information

www.rp-group.com/en/item/UEMR418WL



TECHNICAL DATA

Luminaire type	Exit sign
Mounting	Recessed wall mounting
Recognition distance	20 m
Pictograph	Set
Illuminant	LED
Housing color	Transparent
Protection type (IP)	IP40
Impact resistance (IK)	7
Certification	WEEE, CE, 5 years warranty
Insulation class	1
Supply	Self-contained
Monitoring	Wireless Professional (WL)
Bridging time	8 h



Battery	LiFePO4 3,2 V/1,2 Ah
Operating mode	Non-maintained / maintained
Input voltage AC	230 V
Input frequency	50 Hz
Power max.	3,4 W
Power maintained	2,2 W
Power non-maintained	0,8 W
Ambient temperature maintained mode	0 °C to 40 °C
Ambient temperature non-maintained mode	-5 °C to 40 °C
Depth	100 mm
Width	212 mm
Height	110 mm
Weight	0.11
Weight incl. packaging	0.36
Connection cross-section	2.5 mm ²
Switching input	Yes
Emergency light blocking	Yes
Battery connection	Connector
Dimming function	Yes
Luminous flux mains	80 lm
Luminous flux emergency	40 lm
GTIN	4260766550133



TECHNICAL DRAWING

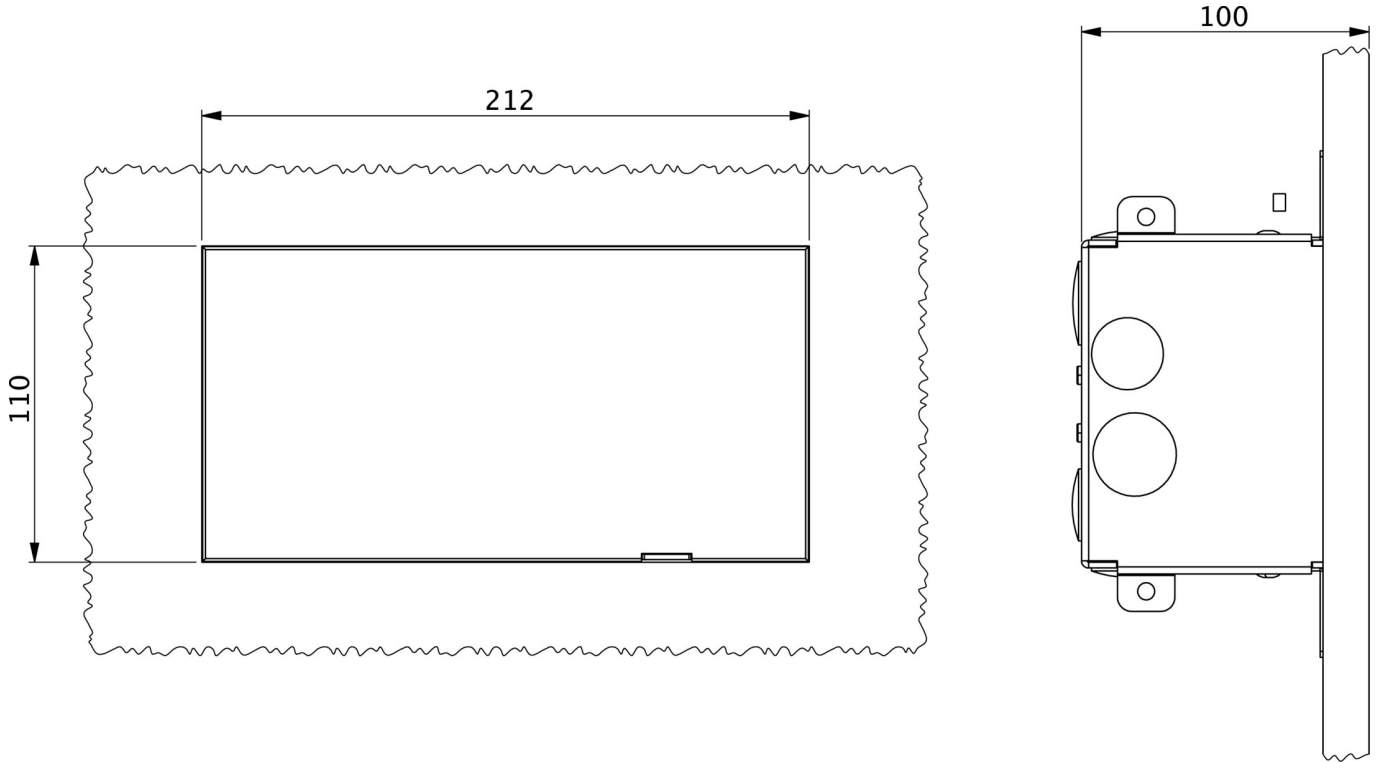

As of: 30.04.2026 - Subject to technical changes and errors.